

# Raffvorhang-Systeme





## Batteriebetriebenes Raffvorhang-System

# Silent Gliss® 2345

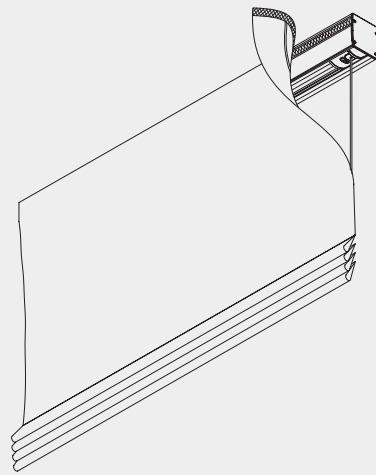

### Produktmerkmale

- Batteriebetriebenes Raffvorhang-System für den Wohn- und Objektbereich.
- Die Technik (inklusive Motor) ist vollständig in das elegante Kopfprofil integriert.
- Die Batterie ist hinter dem Behang versteckt und kann einfach ausgetauscht werden.
- Die Batterie hat eine Haltbarkeit bis zu drei Jahren (abhängig von Gebrauch, Systemgröße, Stoff, Batterietyp und Raumtemperatur).
- Ein neuer Schnurmechanismus erleichtert das Abnehmen des Behanges zur Reinigung.
- Das System ist erhältlich bis maximal 6 m Breite und 6 m Höhe möglich. Max. Gewicht 2,5 kg.
- Einfache Wand- oder Deckenmontage.
- Das System wird montagefertig geliefert, inkl. Motor und Behang.
- Das System kann per Funkwandschalter oder Funkhandsender bedient werden.



2345

## Profil- und Biegeinformation

### Kassette

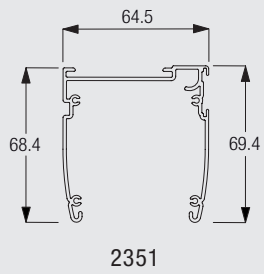

### Welle

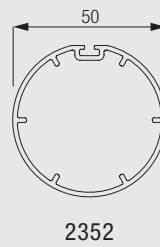

## Maßangaben System



6 m



60 cm



6 m



2,5 kg (inkl.  
Beschwerungsprofil und  
Querstäbe)

## System Option

### Funksteuerungs-System

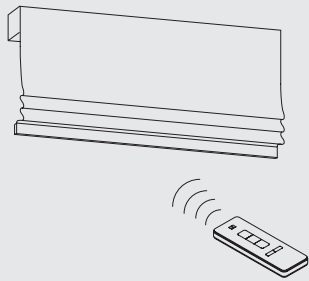

Der Motor ist mit einem integrierten Funkempfänger ausgestattet. In Kombination mit dem Funksteuerungs-System bietet es ein Maximum an Komfort ohne Verdrahten.



2345

### Batterieaustausch

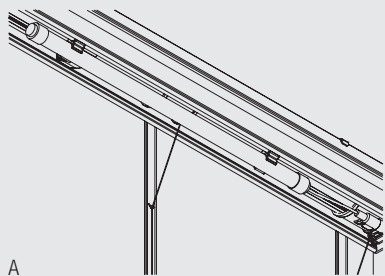

A

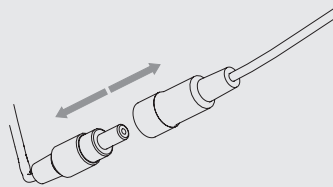

B

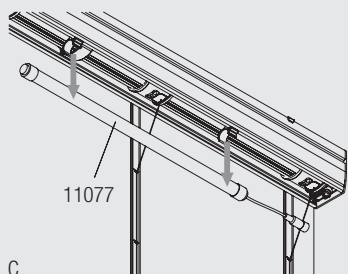

C

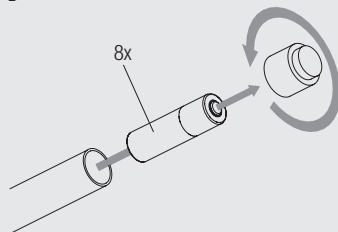

D

## Montage- und Nähinformation

### Positionierung Träger

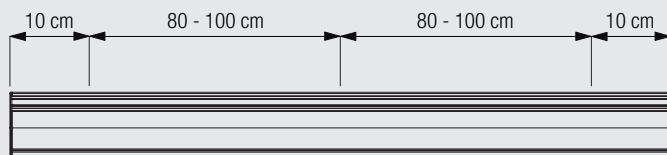

### Fixierung der Kordel

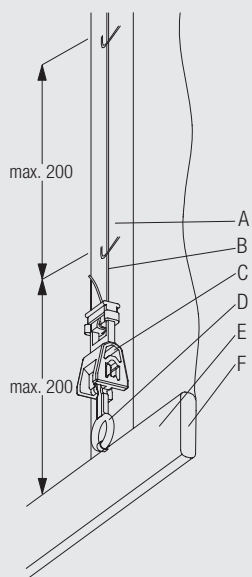

Ausführung ohne Querstäbe, mit Laschenband 3074

- A: Laschenband 3074
- B: Kordel 2216
- C: Kindersicherungshaken 3075
- D: Kindersicherheitsverriegelung 3076
- E: Hohlsaum
- F: Beschwerungsprofil 2004 / 2016

Achtung: Abstand nicht größer als 200 mm an der Rückseite des Behanges.

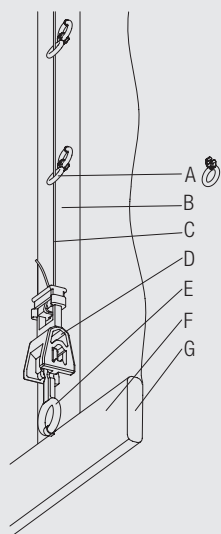

Ausführung ohne Querstäbe, mit Ringband 2164

- A: Kindersicherungsöse 3078
- B: Ringband 2164
- C: Kordel 2216
- D: Kindersicherungshaken 3075
- E: Kindersicherheitsverriegelung 3076
- F: Hohlsaum
- G: Beschwerungsprofil 2004 / 2016



2345

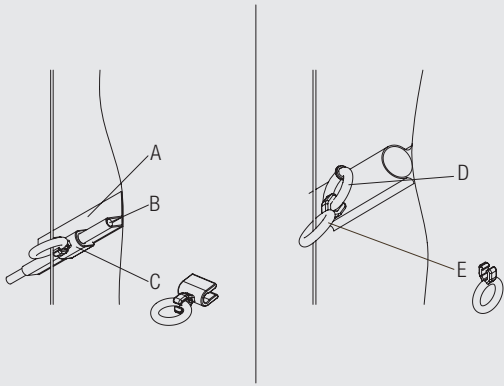

Ausführung mit Querstäben:

- A: Band 2136
- B: Querstab 2135
- C: Kindersicherungsöse 3069
- D: Ring 2093
- E: Kindersicherungsöse 3078

## Einfache Reinigung / pflegeleicht durch neuen Schnurmechanismus

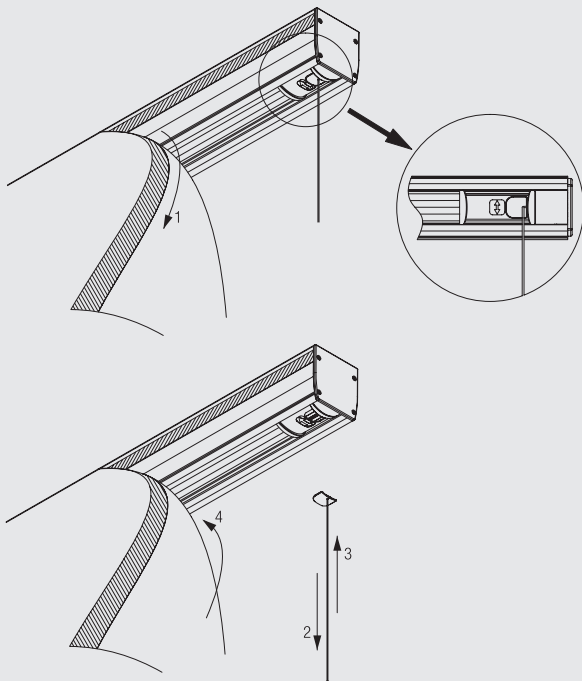

Der neu entwickelte Schnurmechanismus ermöglicht ein einfaches Auf- und Abhängen des Behanges.

Vorbereitung: Vorhang muss komplett nach unten gefahren werden.

1. Vorhang von Klettband lösen.
2. Herausziehen des Pins mittels Ziehimpuls an der Kordel.
3. Nach der Reinigung, Pin wieder in die vorgesehene Öffnung drücken.
4. Vorhang wieder an das Klettband drücken.

## Montage

### Deckenmontage mit Spanner 3003

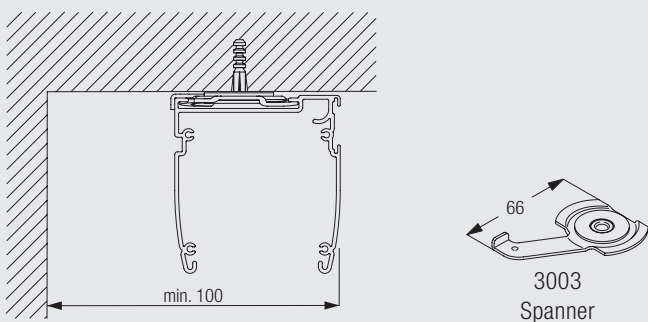

## Deckenmontage mit Träger 2521

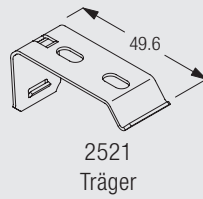
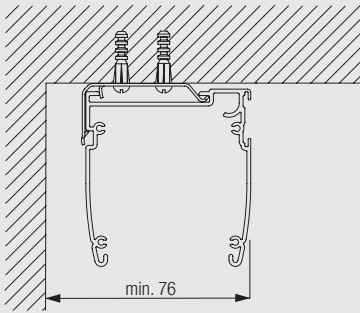

## Decken- und Wandmontage mit Träger 2363

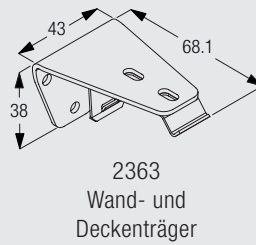
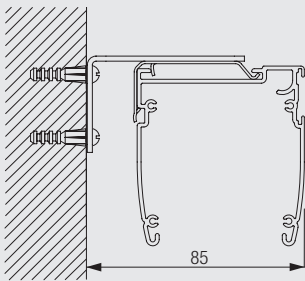

## Wandmontage mit Träger 3134-38 und 2521

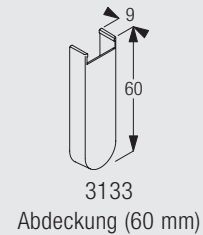
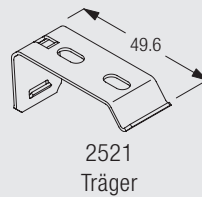
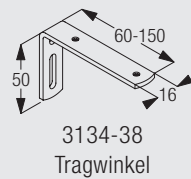
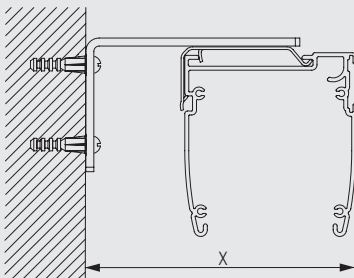

Schrauben M4 x 6 für Träger 2521.

## Wandmontage mit Träger 3271, 3273-74 und 2521

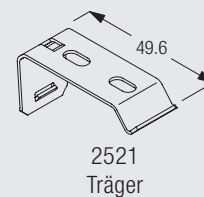
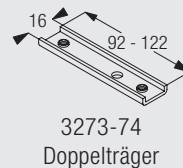
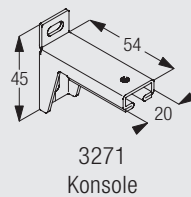
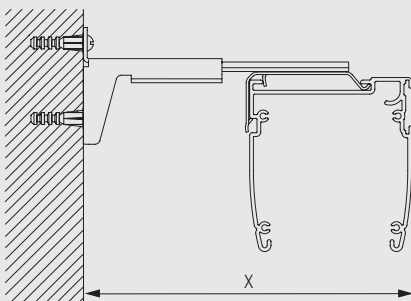

Schrauben M4 für Träger 2521.

## Standard Zubehör

2004 Beschwerungsprofil



2216 Kordel















2221	Velcro Band		2353	Motorabdeckung	
2354	Abdeckung		2357	Pin	
2358	Hülle		2359	Support	
2361	Adapter		2368	Motor-Adapterplatte	
3003	Spanner		3069	Kindersicherheitsöse	
3075	Kindersicherungshaken		3076	Kindersicherheitsverriegelung	
3078	Kindersicherheitsöse		11071	Motorantrieb	
11074	Motor Adapter		11076	Motor, 1.2 Nm	
11077	Batteriebox		11085	Halter Batteriebox	
11099	Alkalische AA Batterie				



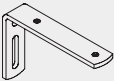
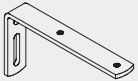
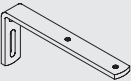
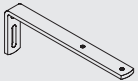
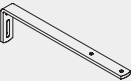

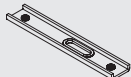

## Optional Zubehör





2345

2136	Band		2137	Querstab aus Fiberglas, 4 mm	
2144	Profil		2363	Wand- und Deckenträger	
2521	Träger		3055	Haken	
3133	Abdeckung (60 mm)		3134	Tragwinkel (60 mm)	
3135	Tragwinkel (80 mm)		3136	Tragwinkel (100mm)	
3137	Tragwinkel (120mm)		3138	Tragwinkel (150mm)	
3139	Tragwinkel (200mm)		3271	Konsole	
3273	Doppelträger (92 mm)		3274	Doppelträger (122 mm)	



10946	Funk-Handfernbedienung, 1-Kanal		10947	Funk-Handfernbedienung, 2+1-Kanal	
10948	Funk-Handfernbedienung, 6+1-Kanal		10949	Funkwandschalter, 1-Kanal	
10950	Funkwandschalter, 2-Kanal		10951	Funkwandschalter, 5+1-Kanal	

## Nähezubehör

2093	Ring		2539	Flauschband	
3074	Ösenband (nur bei Liefer. mit Stoff)				

## Zubehör vermaßt

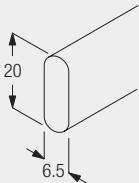
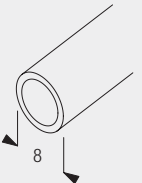
2004	Beschwerungsprofil		2144	Profil	
------	--------------------	--	------	--------	--

## Motoren / Bedienungsarten

### Motor Silent Gliss 11076

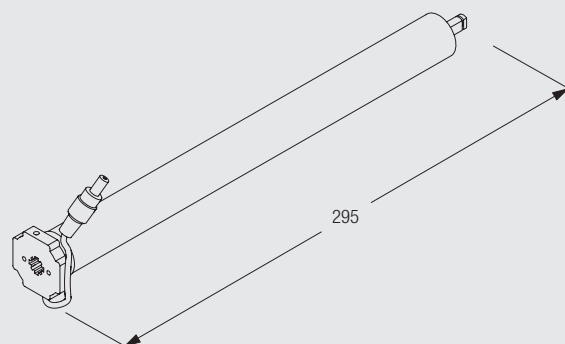

- Spannung: DC 12 V
- Frequenz: 1.2 Nm
- Geschwindigkeit: 30 rpm
- Leistung: 6.6 W
- Strom: 550 mA



2345

## Bedienungsart

### Funkhandsender und Funkwandschalter

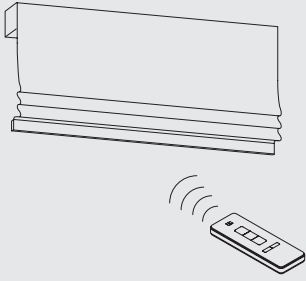

Der Motor ist mit integriertem Funkempfänger ausgestattet. In Kombination mit den Silent Gliss Funksteuerungen bietet dieses System ein Maximum an Komfort.



2345



2345

[www.silentgliss.de](http://www.silentgliss.de)

Silent Gliss GmbH  
Industriestr. 2  
D - 79541 Lörrach  
Tel. +49 (0) 7621 6607 0  
Fax +49 (0) 7621 6607 800

[info@silentgliss.de](mailto:info@silentgliss.de)

[www.silentgliss.at](http://www.silentgliss.at)

Silent Gliss GesmbH  
Jochen Rindt Strasse 1  
A - 1230 Wien  
Tel. +43 (0) 1 615 02 73  
Fax +43 (0) 1 615 02 73 88

Vertriebsbüro / Schauraum  
Stubenring 6  
A - 1010 Wien  
Tel. +43 (0) 1 513 16 77  
Fax +43 (0) 1 513 16 77-88

[info@silentgliss.at](mailto:info@silentgliss.at)